

Article number: 201130825ST
 Description: E+G Lifting pins in Steel,
 GN 1130-8-25-ST

Measures

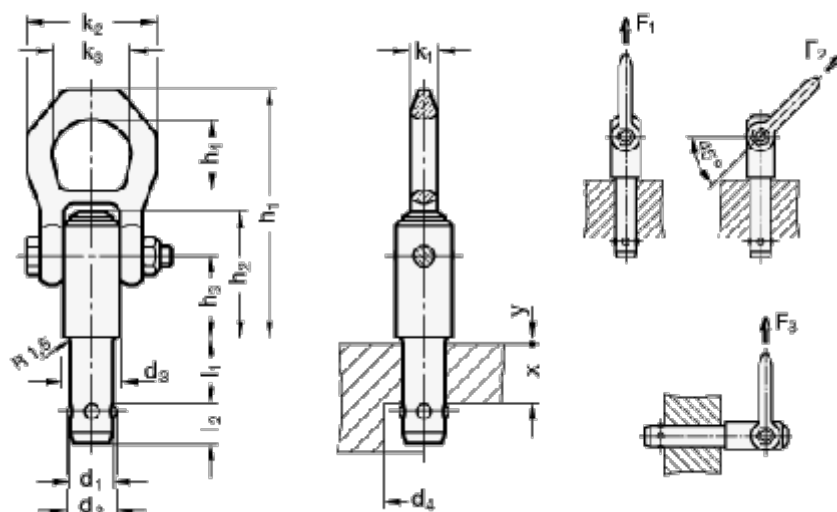

d1	= 8	h4	= 27	y = 1.5
d2	= 9.35	l1	= 25	
d3	= 21.5	l2	= 8.75	
d4	= 9.9	k1	= 11	
F1/F2/F3 load in kN	= 1,5/1,2/0,5	k2	= 49	
h1	= 87.5	k3	= 30	
h2	= 38.5	Weight (g)	= 229	
h3	= 25.7	x	= 10	